

JUNIPER®

THIN Vertical Suspension Remote Installation Guide

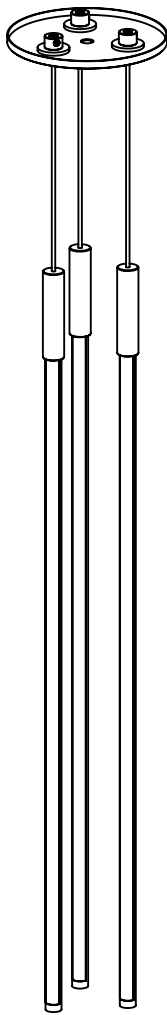

3-LIGHT TUBE
Configuration

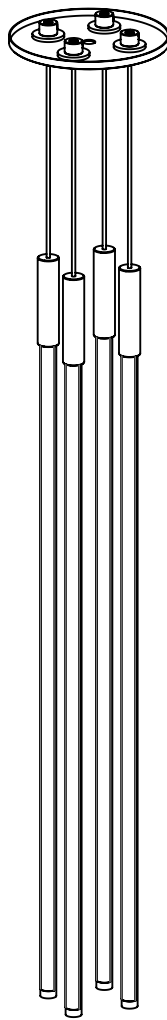

4-LIGHT TUBE
Configuration

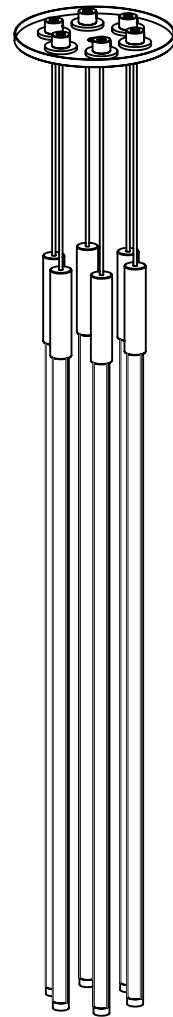

6-LIGHT TUBE
Configuration

SHOWN ARE EXAMPLES OF CONFIGURATION POSSIBILITIES. SPECIFIC FIXTURE CONFIGURATION MAY VARY.

WARNING

**A LICENSED ELECTRICIAN SHOULD PERFORM INSTALLATION.
DISCONNECT MAIN POWER AT THE SOURCE PRIOR TO INSTALLATION.**

INSTRUCTIONS MEANT FOR A REMOTE CLASS 2 DRIVER.

DUE TO THE SIZE OF THE FIXTURE, EXTRA CAUTION IS REQUIRED WHEN HANDLING.

PREFERABLY, TWO PEOPLE SHOULD BE INVOLVED IN THE INSTALLATION OF THE FIXTURE.

STEP 1: JUNCTION BOX COVER PLATE INSTALLATION INSTRUCTIONS

1

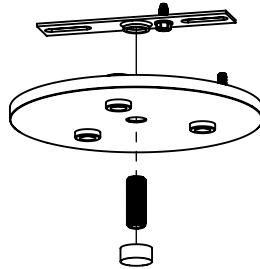

FIGURE 1

Remove nut and threaded rod from the canopy cover to release the crossbar.

2

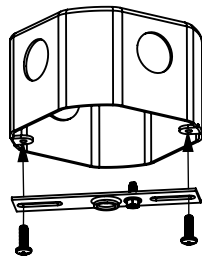

FIGURE 2

Attach the crossbar to the junction box using provided screws.

3

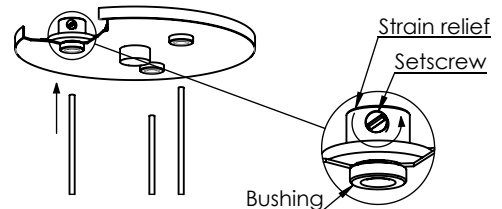

FIGURE 3

Loosen the set screw on the strain relief. Pass power cable, through Bushing and strain relief as shown. Adjust the length of power cord for desired suspension height. Tighten setscrew on strain relief after adjustment.

3

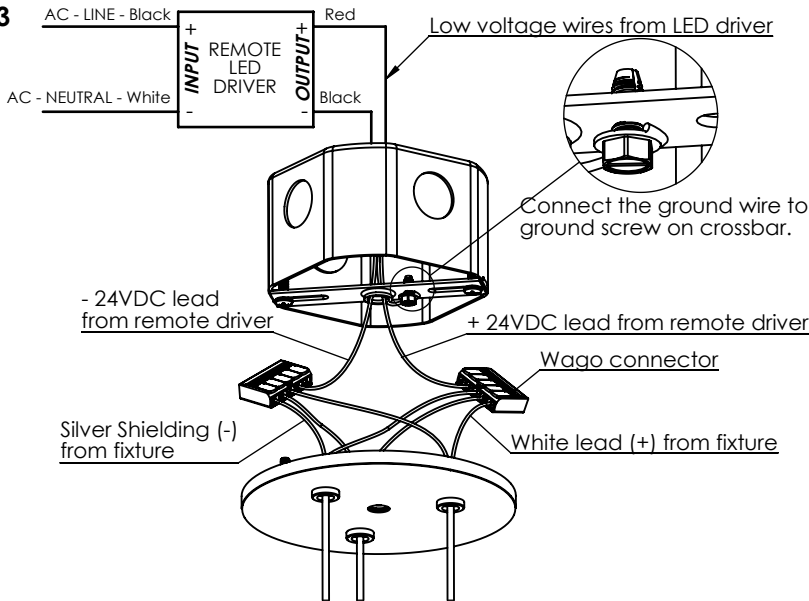

FIGURE 4

Connect wires according to diagram (wago connector provided). **Wires to and from the driver are not included.**

4

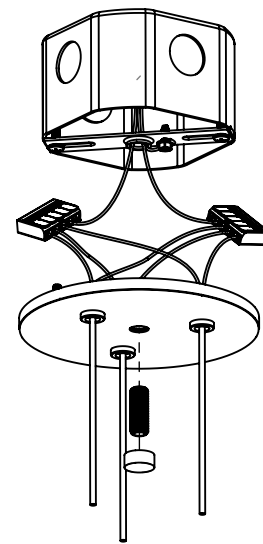

FIGURE 5

Place wires inside junction box. Screw threaded rod and nut into crossbar to attach canopy plate to junction box.

STEP 2: LIGHT TUBE INSTALLATIONS

The THIN Suspension fixture is designed with an innovative magnetic connection. Simply insert the light tube into the connector for electrical contact to be made.

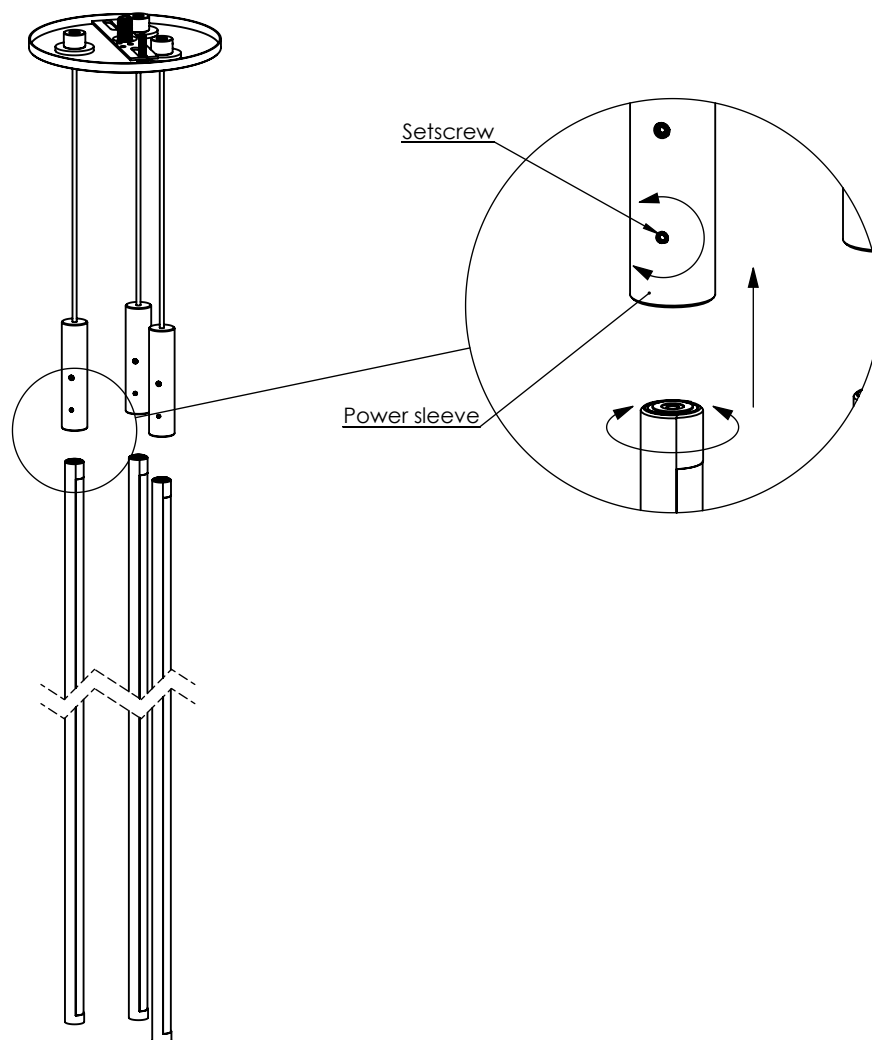

FIGURE 6

- a. Loosen the set screw on the power sleeve as shown.
- b. Reconnect main power and insert light tube into the power sleeve. Push light tube in carefully until it illuminates.
- c. Rotate the light tube to change the direction of the light.
- d. Tighten the set screw on the power sleeve after adjusting the direction.

CARE INSTRUCTIONS

Brass will patina over time like other natural metals and regular care is required in order to retain the quality finish of your THIN fixture for years to come.

Gently wipe with a damp cloth to remove dirt, dust, and fingerprints.

Do not use any chemical cleaning solution.

Use indoors only.